



MADE EASY

India's Best Institute for IES, GATE & PSUs

GATE 2022

ELECTRICAL ENGINEERING

Exam held on
05/02/2022

Questions & Solutions



Corporate Office : 44-A/1, Kalu Sarai, New Delhi - 110016

MADE EASY Centres : • Delhi • Hyderabad • Bhopal • Jaipur
• Lucknow • Pune • Bhubaneswar • Kolkata • Patna



9021300500



www.madeeasy.in

SECTION - A

GENERAL APTITUDE

- Q.1** As you grow older, an injury to your _____ may take longer to _____.
- (a) heel / heel (b) heal / heel
(c) heal / heal (d) heel / heal

Ans. (d)

End of Solution

- Q.2** In a 500 m race, P and Q have speeds in the ratio of 3 : 4. Q starts the race when P has already covered 140 m. What is the distance between P and Q (in m) when P wins the race?
- (a) 20 (b) 40
(c) 60 (d) 140

Ans. (a)

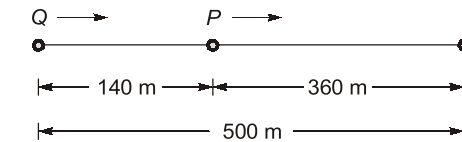

$$P : Q = 3 : 4$$

$$P = 3x$$

$$Q = 4x$$

So, $3x = 360$

$$x = 120 \text{ m}$$

$$Q = 4x = 4 \times 120 = 480 \text{ m}$$

When P reaches 500 metres and Q reaches only 480 metres.

\therefore P wins by 20 m.

End of Solution

- Q.3** Three bells P, Q and R are rung periodically in a school. P is rung every 20 minutes; Q is rung every 30 minutes and R is rung every 50 minutes. If all the three bells are rung at 12:00 PM, when will the three bells ring together again the next time?
- (a) 5:00 PM (b) 5:30 PM
(c) 6:00 PM (d) 6:30 PM

Ans. (a)

Three bells P, Q, R.

$$P = 20 \text{ minutes}$$

$$Q = 30 \text{ minutes}$$

$$R = 50 \text{ minutes}$$

$$\text{L.C.M. of } 20, 30, 50 = 300 \text{ minutes} = 5 \text{ hours}$$

$$12:00 \text{ PM} + 5 \text{ hours} = 5:00 \text{ P.M.}$$

So, three bells ring together again at 5:00 P.M.

End of Solution

- Q.4** Given below are two statements and four conclusions drawn based on the statements.
 Statement I : Some bottles are cups.
 Statement II : All cups are knives.
 Conclusion I : Some bottles are knives.
 Conclusion II : Some knives are cups.
 Conclusion III : All cups are bottles.
 Conclusion IV : All knives are cups.
 Which one of the following options can be logically inferred?
 (a) Only conclusion I and conclusion II are correct.
 (b) Only conclusion II and conclusion III are correct.
 (c) Only conclusion II and conclusion IV are correct.
 (d) Only conclusion III and conclusion IV are correct.

Ans. (a)

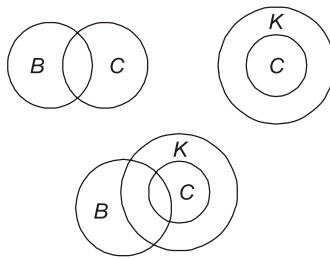

Conclusions I and II are correct.

End of Solution

- Q.5** The figure below shows the front and rear view of a disc, which is shaded with identical patterns. The disc is flipped once with respect to any one of the fixed axes 1-1, 2-2 or 3-3 chosen uniformly at random. What is the probability that the disc DOES NOT retain the same front and rear views after the flipping operation?

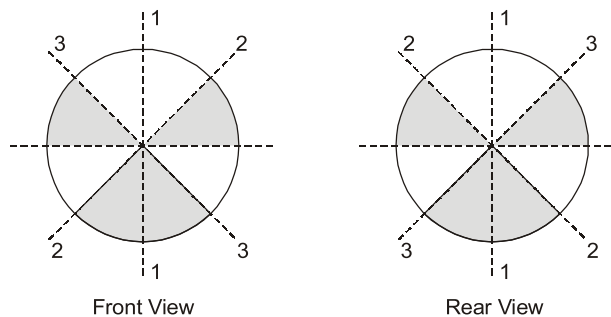

- (a) 0
 (b) $\frac{1}{3}$
 (c) $\frac{2}{3}$
 (d) 1

Ans. (c)

$$n = \text{Total} = 3$$

$m = \text{Favourable} = \text{disc does not retain the same front and rear views after the flipping} = 2$

$$\text{Probability} = \frac{m}{n} = \frac{2}{3}$$

End of Solution

Q.6 Altruism is the human concern for the well being of others. Altruism has been shown to be motivated more by social bonding, familiarity and identification of belongingness to a group. The notion that altruism may be attributed to empathy or guilt has now been rejected.

Which one of the following is the CORRECT logical inference based on the information in the above passage?

- (a) Humans engage in altruism due to guilt but not empathy.
- (b) Humans engage in altruism due to empathy but not guilt.
- (c) Humans engage in altruism due to group identification but not empathy.
- (d) Humans engage in altruism due to empathy but not familiarity.

Ans. (c)

End of Solution

Q.7 There are two identical dice with a single letter on each of the faces. The following six letters : Q, R, S, T, U and V, one on each of the faces. Any of the six outcomes are equally likely.

The two dice are thrown once independently at random.

What is the probability that the outcomes on the dice were composed only of any combination of the following possible outcomes : Q, U and V?

- (a) $\frac{1}{4}$
- (b) $\frac{3}{4}$
- (c) $\frac{1}{6}$
- (d) $\frac{5}{36}$

Ans. (a)

Given two dice.

$$P(E) = \frac{\text{Favourable}}{\text{Total}}$$

$$P(E) = \frac{3}{6} \times \frac{3}{6} = \frac{1}{4}$$

End of Solution

- Q.8** The price of an item is 10% cheaper in an online store S compared to the price at another online store M. Store S charges Rs. 150 for delivery. There are no delivery charges for orders from the store M. A person bought the item from the store S and saved Rs. 100. What is the price of the item at the online store S (in Rs.) if there are no other charges than what is described above?
- (a) 2500 (b) 2250
(c) 1750 (d) 1500

Ans. (b)

Given online stores S and M.

Cap price on M = Rs. x

Price on S = $(x - 0.1x) = 0.9x$

Delivery charges on S = Rs. 100

$$\therefore x - (0.9x + 150) = 100$$

$$0.1x - 150 = 100$$

$$x = 2500$$

$$\begin{aligned} \text{Price on store S} &= 0.9 \times 2500 \\ &= 2250 \end{aligned}$$

End of Solution

- Q.9** The letters P, Q, R, S, T and U are to be placed one per vertex on a regular convex hexagon, but not necessarily in the same order. Consider the following statements :
- The line segment joining R and S is longer than the line segment joining P and Q.
 - The line segment joining R and S is perpendicular to the line segment joining P and Q.
 - The line segment joining R and U is parallel to the line segment joining T and Q.
- Based on the above statements, which one of the following options is CORRECT?
- (a) The line segment joining R and T is parallel to the line segment joining Q and S.
(b) The line segment joining T and Q is parallel to the line joining P and U.
(c) The line segment joining R and P is perpendicular to the line segment joining U and Q.
(d) The line segment joining Q and S is perpendicular to the line segment joining R and P.

Ans. (a)

End of Solution

- Q.10** An ant is at the bottom-left corner of a grid (point P) as shown below in the figure. It aims to move to the top-right corner of the grid. The ant moves only along the lines marked in the grid such that the current distance to the top-right corner strictly decreases. Which one of the following is a part of a possible trajectory of the ant during the movement?

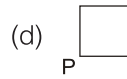
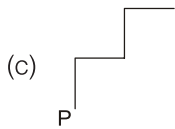
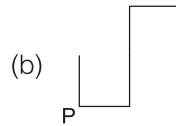
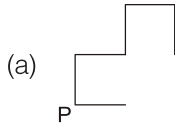
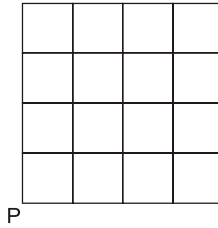

Ans. (c)

End of Solution



SECTION - B

TECHNICAL

Q.11 The transfer function of a real system, $H(s)$, is given as :

$$H(s) = \frac{As+B}{s^2 + Cs + D}$$

where A , B , C and D are positive constants. This system cannot operate as

- (a) low pass filter. (b) high pass filter.
(c) band pass filter. (d) an integrator.

Ans. (b)

$$H(s) = \frac{As+B}{s^2 + Cs + D}$$

At low = freq. ($s = 0$)

$$H(0) = \frac{B}{D}$$

At high – freq. ($s = \infty$)

$$H(\infty) = 0$$

Since, $H(\infty)$ should be non-zero for HPF. So, the above system cannot be operated as HPF because for high pass filter should pass high-frequency component i.e $H(\infty)$ should be non-zero.

End of Solution

Q.12 For an ideal MOSFET biased in saturation, the magnitude of the small signal current gain for a common drain amplifier is

- (a) 0 (b) 1
(c) 100 (d) Infinite

Ans. (d)

Voltage gain $A_V = 1$

$$\text{Current gain, } A_I = \frac{i_s}{i_G} = \frac{i_s}{0} = \infty$$

End of Solution

Q.13 The most commonly used relay, for the protection of an alternator against loss of excitation, is

- (a) offset Mho relay. (b) over current relay.
(c) differential relay. (d) Buchholz relay.

Ans. (a)

End of Solution



MADE EASY

India's Best Institute for IES, GATE & PSUs

Under the guidance of

Mr. B. Singh

CMD, MADE EASY GROUP



- Quality Teaching
- Well Planned Curriculum
- Systematic Subject Sequence
- Comprehensive Study Materials

Admission open in Foundation Courses

**GATE
2023**

**ESE 2023 +
GATE 2023**

- ✓ Classes by experienced & renowned faculties.
- ✓ Systematic subject sequence.
- ✓ Efficient teaching with comprehensive coverage.
- ✓ Concept practice through workbook solving.
- ✓ Regular performance assessment through class tests.
- ✓ Exam oriented learning ecosystem.
- ✓ Timely completion of syllabus.
- ✓ Similar teaching pedagogy in online & offline classes.
- ✓ Comprehensive & updated theory & practice books.

OFFLINE CLASSES

Special Discount to Ex. MADE EASY students in CLASSROOM COURSES :
50% OF FEE PAID
will be discounted (any course)

www.madeeasy.in

Regular Batches Commencement dates at Delhi Centre

CE & ME

- 23rd Feb, 2022 • 21st Mar, 2022
- 13th Apr, 2022 • 04th May, 2022 • 25th May, 2022

EE & EC

- 24th Feb, 2022 • 22nd Mar, 2022
- 14th Apr, 2022 • 05th May, 2022 • 26th May, 2022

CS

- 24th Feb, 2022 • 23rd Mar, 2022 • 06th May, 2022

CH

- 21st Feb, 2022 • 23rd Mar, 2022 • 11th May, 2022

Batches commencing in Mar, April & May at all centres of MADE EASY.
For more details, visit our website.

LIVE ONLINE CLASSES

Download the app now



Android



iOS

www.madeeasyprime.com

New Batches Commencement Dates

Facility to CONVERT ONLINE to OFFLINE

Morning Batches

- Medium : Hinglish | Time : 8:00 AM - 2:00 PM
- CE: 3rd Feb & 8th Mar, 2022 • ME: 14th Feb & 8th Mar, 2022

Evening Batches

Medium : Hinglish | Time : 6:00 PM - 10:00 PM

- CE, ME, EE, EC : 3rd Feb & 8th Mar, 2022
- CH : 3rd Feb & 8th Mar, 2022

Evening Batches

Medium : English | Time : 6:00 PM - 10:00 PM

- CE : 17th Feb, 2022 & 8th Mar, 2022
- ME : 30th Jan, 2022 & 8th Mar, 2022
- EE, EC, IN : 7th Feb, 2022 & 8th Mar, 2022
- CS : 1st Feb, 2022 & 8th Mar, 2022

Corporate Office : 44-A/1, Kalu Sarai, Near Hauz Khas Metro Station, New Delhi-110016

MADE EASY Centres : Delhi | Hyderabad | Jaipur | Lucknow | Bhopal | Bhubaneswar | Pune | Patna | Kolkata

☎ 9021300500

🌐 www.madeeasy.in

Q.14 The geometric mean radius of a conductor, having four equal strands with each strand of radius r , as shown in the figure below, is

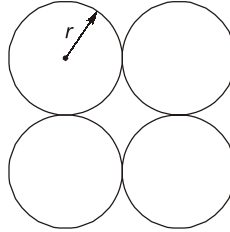

- (a) $4r$ (b) $1.414r$
(c) $2r$ (d) $1.723r$

Ans. (d)

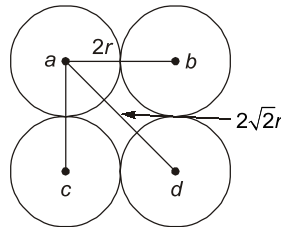

$$\begin{aligned} \text{GMR} &= [D_{aa} D_{ab} D_{ac} D_{ad}]^{1/4} \\ &= [e^{-1/4} r \cdot 2r \cdot 2r \cdot 2\sqrt{2}r]^{1/4} \\ \text{GMR} &= 1.723r \end{aligned}$$

End of Solution

Q.15 The valid positive, negative and zero sequence impedances (in p.u.), respectively, for a 220 kV, fully transposed three-phase transmission line, from the given choices are
(a) 1.1, 0.15 and 0.08 (b) 0.15, 0.15 and 0.35
(c) 0.2, 0.2 and 0.2 (d) 0.1, 0.3 and 0.1

Ans. (b)

For 3- ϕ full transposed transmission line,

$$X_1 \cong X_2 < X_0$$

So suitable answer from given options is option (b).

$$\begin{aligned} X_1 &= X_2 = 0.15 \\ X_0 &= 0.35 \end{aligned}$$

End of Solution

Q.16 The steady state output (V_{out}), of the circuit shown below, will

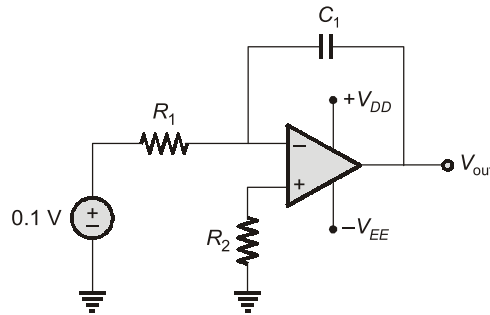

- (a) saturate to $+V_{DD}$ (b) saturate to $-V_{EE}$
(c) become equal to 0.1 V (d) become equal to -0.1 V

Ans. (b)

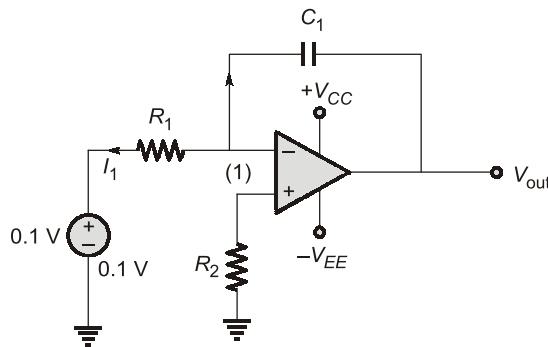

KCL at Node (i)

$$I_1 + I_2 = 0$$

$$\frac{V_i - 0}{R_1} + C_1 \times \frac{d}{dt}(V_{out} - 0) = 0$$

$$\frac{dV_{out}}{dt} = -\frac{V_i}{R_1 C_1}$$

$$V_A = 0$$

$$V_{out} = -\frac{1}{R_1 C_1} \int V_i dt$$

$$V_i = 0.1 \text{ V}$$

$$V_{out} = -\frac{1}{R_1 C_1} \int 0.1 \times dt = -\frac{0.1}{R_1 C_1} \times t$$

$$V_{out} = -k \times t$$

The output will be constant i.e. $-V_{EE}$.

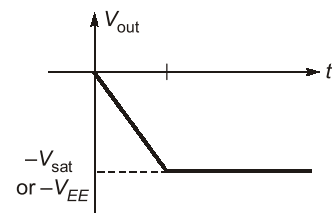

End of Solution

Q.17 The Bode magnitude plot of a first order stable system is constant with frequency. The asymptotic value of the high frequency phase, for the system, is -180° . This system has

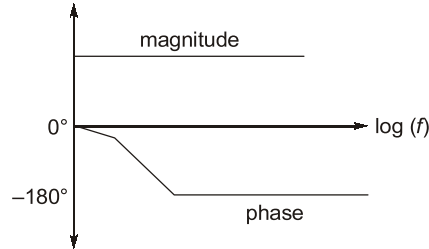

- (a) one LHP pole and one RHP zero at the same frequency.
- (b) one LHP pole and one LHP zero at the same frequency.
- (c) two LHP poles and one RHP zero.
- (d) two RHP poles and one LHP zero.

Ans. (a)

$$P = 1$$

Possibilities, $\frac{s-1}{s+1}$, $\frac{1-s}{1+s}$

Number of poles, $P = 1$

Number of zeros, $Z = 1$

End of Solution

Q.18 A balanced Wheatstone bridge $ABCD$ has the following arm resistances :
 $R_{AB} = 1 \text{ k}\Omega \pm 2.1\%$; $R_{BC} = 100 \Omega \pm 0.5\%$; R_{CD} is an unknown resistance;
 $R_{DA} = 300 \Omega \pm 0.4\%$. The value of R_{CD} and its accuracy is

- (a) $30 \Omega \pm 3 \Omega$
- (b) $30 \Omega \pm 0.9 \Omega$
- (c) $3000 \Omega \pm 90 \Omega$
- (d) $3000 \Omega \pm 3 \Omega$

Ans. (b)

Under balanced condition,

$$R_{CD} = \frac{R_{BC} \times R_{DA}}{R_{AB}} = \frac{(100 \pm 0.5\%)(300 \pm 0.4\%)}{(1000 \pm 2.1\%)}$$

$$R_{CD} = \frac{100 \times 300}{1000} + (0.5\% + 0.4\% + 2.1\%)$$

$$R_{CD} = 30 \pm 3\%$$

$$\% \text{ Error} = \pm 3\%$$

$$R_{CD} = 30 \pm 30 \times \frac{3}{100} = 30 \pm 0.9 \Omega$$

End of Solution

Q.19 The open loop transfer function of a unity gain negative feedback system is given by

$$G(s) = \frac{k}{s^2 + 4s - 5}. \text{ The range of } k \text{ for which the system is stable, is}$$

- (a) $k > 3$ (b) $k < 3$
(c) $k > 5$ (d) $k < 5$

Ans. (c)

Characteristics equation, $1 + G(s) = 0$

$$s^2 + 2s + (K - 5) = 0$$

By Routh table analysis,

$$k > 5 \text{ and } k > 0$$

For stable system $k > 5$

End of Solution

Q.20 Consider a 3×3 matrix A whose (i, j) -th element, $a_{i,j} = (i - j)^3$. Then the matrix A will be

- (a) symmetric. (b) skew-symmetric.
(c) unitary. (d) null.

Ans. (b)

$$A = [a_{ij}]_{3 \times 3}, a_{ij} = (i - j)^3$$

$$\text{for } i = j \Rightarrow a_{ii} = (i - i)^3 = 0 \quad \forall i$$

$$\text{for } i \neq j \Rightarrow a_{ij} = (i - j)^3 = -(j - i)^3 \\ = -(j - i)^3 = -a_{ji}$$

$\therefore A_{3 \times 3}$ is a skew-symmetric matrix.

End of Solution

Q.21 In the circuit shown below, a three-phase star-connected unbalanced load is connected to a balanced three-phase supply of $100\sqrt{3}$ V with phase sequence ABC . The star connected load has $Z_A = 10 \Omega$ and $Z_B = 20\angle 60^\circ \Omega$. The value of Z_C in Ω , for which the voltage difference across the nodes n and n' is zero, is

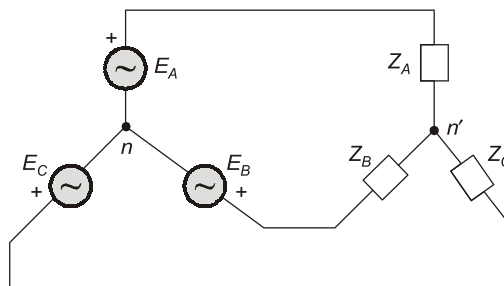

- (a) $20\angle -30^\circ$ (b) $20\angle 30^\circ$
(c) $20\angle -60^\circ$ (d) $20\angle 60^\circ$

Ans. (c)

n and n' are same potential,

So, $I_A + I_B + I_C = 0$

$$\frac{E_A}{Z_A} + \frac{E_B}{Z_B} + \frac{E_C}{Z_C} = 0$$

$$\frac{100\angle 0^\circ}{10} + \frac{100\angle -120^\circ}{20\angle 60^\circ} + \frac{100\angle 120^\circ}{Z_C} = 0$$

$$10 + 5\angle -180^\circ + \frac{100\angle 120^\circ}{Z_C} = 0$$

$$Z_C = 20\angle -60^\circ \Omega$$

End of Solution

Q.22 A charger supplies 100 W at 20 V for charging the battery of a laptop. The power devices, used in the converter inside the charger, operate at a switching frequency of 200 kHz. Which power device is best suited for this purpose?

- (a) IGBT (b) Thyristor
(c) MOSFET (d) BJT

Ans. (c)

End of Solution

Q.23 A long conducting cylinder having a radius b is placed along the z -axis. The current density is $\vec{J} = J_a r^3 \hat{z}$ for the region $r < b$ where r is the distance in the radial direction.

The magnetic field intensity (\vec{H}) for the region inside the conductor (i.e., for $r < b$) is

- (a) $\frac{J_a}{4} r^4$ (b) $\frac{J_a}{3} r^3$
(c) $\frac{J_a}{5} r^4$ (d) $J_a r^3$

Ans. (c)

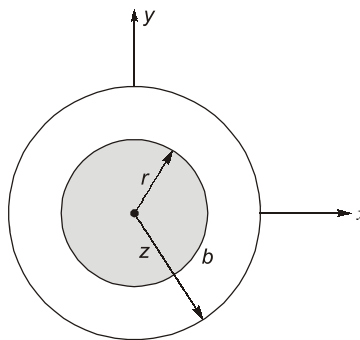

Given : $\vec{J} = J_a r^3 \hat{z}$

$\therefore I = \int_s \vec{J} \cdot d\vec{s}; d\vec{s} = r dr d\phi \hat{z}$

$\Rightarrow I = \int J_a r^3 \hat{z} \cdot r dr d\phi \hat{z}$

$$= J_a \int_{r=0}^r r^4 dr \int_{\phi=0}^{2\pi} d\phi$$

$$= J_a \frac{r^5}{5} \Big|_0^r \cdot \phi \Big|_0^{2\pi} = \frac{J_a (2\pi) r^5}{5}$$

As $\oint \vec{H} \cdot d\vec{L} = I_{enc} = \int_s \vec{J} \cdot d\vec{s}$

$\Rightarrow H(2\pi r) = \frac{J_a (2\pi) r^5}{5}$

$\Rightarrow H = \frac{J_a r^4}{5}$

End of Solution

- Q.24** The type of single-phase induction motor, expected to have the maximum power factor during steady state running condition, is
- (a) split phase (resistance start). (b) shaded pole.
(c) capacitor start. (d) capacitor start, capacitor run.

Ans. (d)

End of Solution

- Q.25** For the circuit shown below with ideal diodes, the output will be

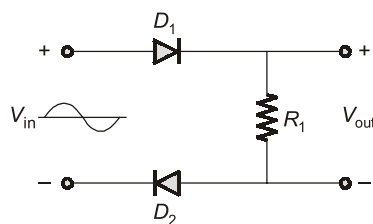

- (a) $V_{out} = V_{in}$ for $V_{in} > 0$ (b) $V_{out} = V_{in}$ for $V_{in} < 0$
(c) $V_{out} = -V_{in}$ for $V_{in} > 0$ (d) $V_{out} = -V_{in}$ for $V_{in} < 0$

Ans. (a)

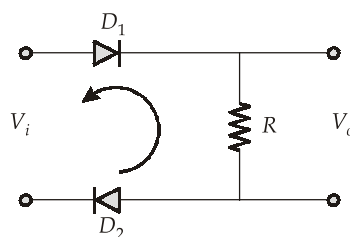

Positive half cycle
 D_1 and D_2 will be ON.

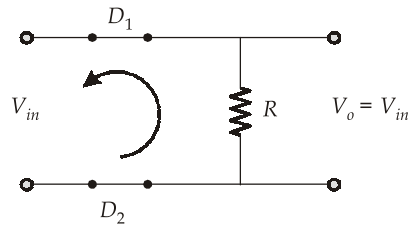

For Negative half cycle
 D_1 and D_2 will be OFF.

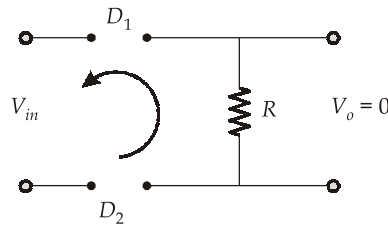

The output waveform

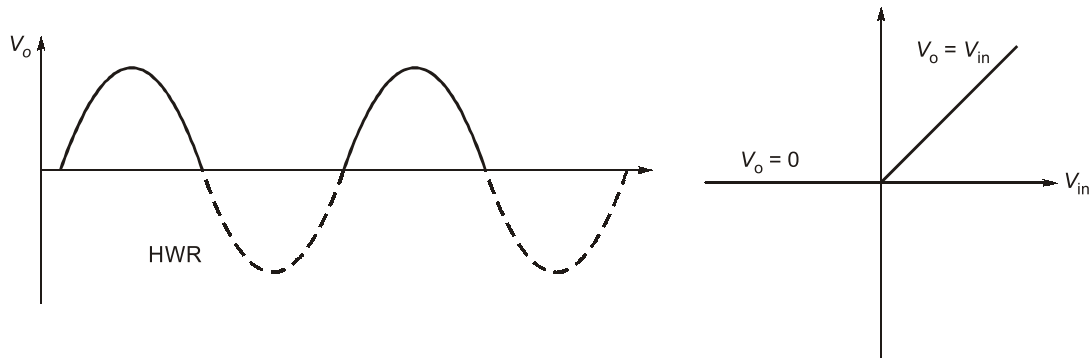

So, $V_o = V_{in}$ for $V_{in} > 0$

End of Solution

Q.26 A MOD-2 and a MOD-5 up-counter when cascaded together results in a MOD ____ counter. (in integer).

Ans. (10)



For overall configuration = Mod $(2 \times 5) = 10$
It will be mod 10 counter.

End of Solution

Q.27 An inductor having a Q -factor of 60 is connected in series with a capacitor having a Q -factor of 240. The overall Q -factor of the circuit is _____. (round off to nearest integer).

Ans. (48)

The overall Q -factor of the circuit is

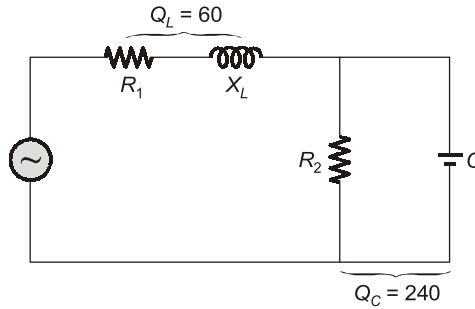

$$Q = \frac{Q_L \cdot Q_C}{Q_L + Q_C}$$

$$Q = \frac{60 \times 240}{60 + 240} = 48$$

End of Solution

Q.28 The network shown below has a resonant frequency of 150 kHz and a bandwidth of 600 Hz. The Q -factor of the network is _____. (round off to nearest integer).

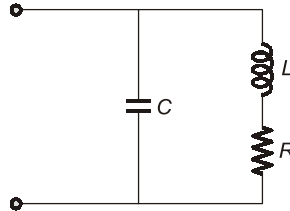

Ans. (250)

Resonance frequency,

$$f_o = 150 \text{ kHz}$$

Bandwidth width, B.W. = 600 Hz

The Q -factor of the network

$$Q = \frac{f_o}{\text{Bandwidth}} = \frac{150k}{600} = 250$$

End of Solution

Q.29 The maximum clock frequency in MHz of a 4-stage ripple counter, utilizing flip-flops, with each flip-flop having a propagation delay of 20 ns, is _____. (round off to one decimal place).

Ans. (12.5)

Given ripple counter 4 flip-flop, $t_p = 20$ nsec for each flip-flop.

$$T = nt_p = 4 \times 20\text{nsec} = 80 \text{ nsec}$$

$$\text{Clock frequency} = \frac{1}{T} = \frac{1}{4 \times 20 \times 10^{-9}} = 12.5 \text{ MHz}$$

End of Solution

Q.30 If only 5% of the supplied power to a cable reaches the output terminal, the power loss in the cable, in decibels, is _____. (round off to nearest integer).

Ans. (13) (12 to 14)

$$\% \text{ power loss} = 95\%$$

Power output as a % of power is 5%

Practically cables power loss in decibels is calculated as

$$\text{Power loss in decibels} = 10 \log\left(\frac{95}{5}\right) \approx 12.78 \approx 13 \text{ db}$$

End of Solution

Q.31 In the circuit shown below, the switch S is closed at $t = 0$. The magnitude of the steady state voltage, in volts, across the 6Ω resistor is _____. (round off to two decimal places).

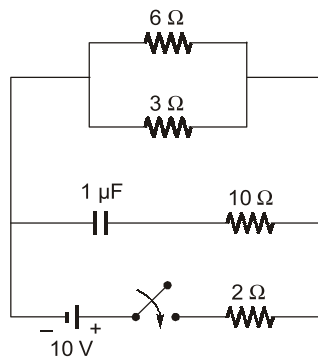

Ans. (5)

In steady state capacitor acts as an open circuit for DC supply.

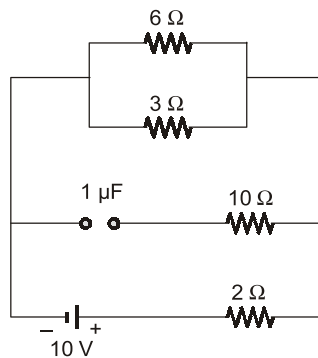



MADE EASY

India's Best Institute for IES, GATE & PSUs



NST

NATIONAL SCHOLARSHIP TEST

For **ESE 2023** & **GATE 2023**
LIVE-ONLINE & OFFLINE COURSES

NST-1

22nd Feb, 2022

For **LIVE-ONLINE** Courses

UP TO **50%** SCHOLARSHIP
in Total Fee

Exam Mode : **ONLINE**

Time Duration : 45 Min | Total Question : 50
Total Marks : 100 | Negative Marking : 0.66 Marks

Note: 50% weightage will be given to marks obtained in B.Tech.
Merit list will be prepared on the basis of NST score & B. Tech marks.

NST-2

27th Feb, 2022

For **CLASSROOM** Courses

UP TO **100%** SCHOLARSHIP
in Tuition Fee

Exam Mode : **OFFLINE**

Time Duration : 60 Min | Total Question: 50
Total Marks : 100 | Negative Marking : 0.66 Marks

Test Centres: Agra, Prayagraj, Bhilai, Chandigarh, Chennai, Mumbai,
Visakhapatnam, Indore, Bengaluru, Nagpur, Jabalpur, Dehradun, Delhi, Bhopal,
Bhubaneswar, Hyderabad, Jaipur, Kolkata, Lucknow, Patna & Pune

Last date to register online : 19th Feb, 2022

Register at : www.madeeasy.in

Scholarship applicable on batches commencing after **1st March, 2022**

Corporate Office : 44-A/1, Kalu Sarai, Near Hauz Khas Metro Station, New Delhi-110016

MADE EASY Centres : Delhi | Hyderabad | Jaipur | Lucknow | Bhopal | Bhubaneswar | Pune | Patna | Kolkata

☎ **9021300500**

🌐 **www.madeeasy.in**

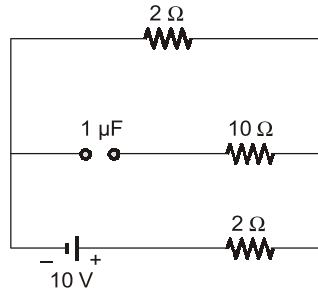

The voltage across 6Ω is

$$V_o = 10 \times \frac{2}{2+2} = 5 \text{ V}$$

End of Solution

Q.32 A single-phase full-bridge diode rectifier feeds a resistive load of 50Ω from a 200 V , 50 Hz single phase AC supply. If the diodes are ideal, then the active power, in watts, drawn by the load is _____. (round off to nearest integer).

Ans. (800)

1- ϕ full bridge diode rectifier,

Load, $R = 50 \Omega$

1- ϕ Active power supply

$$V_s = 200 \text{ Volts}$$

$$P_{0 \text{ avg}} = \frac{V_{0 \text{ rms}}^2}{R}$$

$$V_{0r} = V_{s \text{ rms}} = 200 \quad (\text{for } 1\text{-}\phi \text{ full bridge rectifier})$$

$$P_{0 \text{ avg}} = \frac{200^2}{50} = 800 \text{ W}$$

End of Solution

Q.33 The voltage at the input of an AC-DC rectifier is given by $v(t) = 230\sqrt{2} \sin \omega t$ where $\omega = 2\pi \times 50 \text{ rad/s}$. The input current drawn by the rectifier is given by

$$i(t) = 10 \sin\left(\omega t - \frac{\pi}{3}\right) + 4 \sin\left(3\omega t - \frac{\pi}{6}\right) + 3 \sin\left(5\omega t - \frac{\pi}{3}\right)$$

The input power factor, (rounded off to two decimal places), is ____ lag.

Ans. (0.447)

$$g = \frac{I_{s1}}{I_{sr}} = \frac{10 / \sqrt{2}}{\sqrt{\left(\frac{10}{\sqrt{2}}\right)^2 + \left(\frac{4}{\sqrt{2}}\right)^2 + \left(\frac{3}{\sqrt{2}}\right)^2}}$$

$$g = 0.89$$

$$pF = g \cdot FDF$$

$$pF = g \cdot \cos\left(\frac{\pi}{3}\right) = 0.447$$

End of Solution

Q.34 Two balanced three-phase loads, as shown in the figure, are connected to a $100\sqrt{3}$ V, three-phase, 50 Hz main supply. Given $Z_1 = (18 + j24) \Omega$ and $Z_2 = (6 + j8) \Omega$. The ammeter reading, in amperes, is _____. (round off to nearest integer).

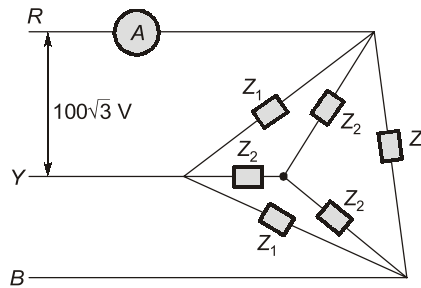

Ans. (20)

Convert Δ - $Y_{Network}$

$$Z'_1 = \frac{Z_1 \times Z_1}{Z_1 + Z_1 + Z_1} = \frac{Z_1}{3} = \frac{18 + j24}{3} = (6 + j8) \Omega$$

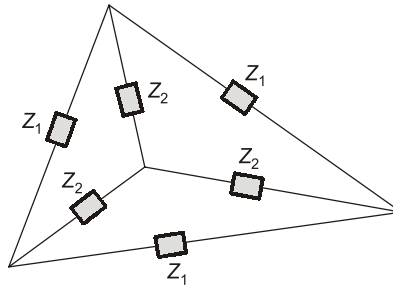

After redrawing network,

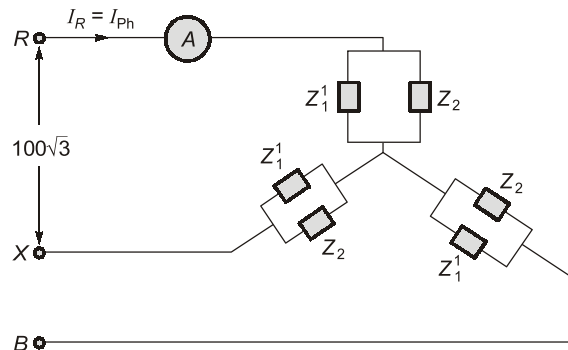

$$\begin{aligned} Z_{eq} &= Z_1' \parallel Z_2 \\ &= (6 + j8) \parallel (6 + j8) \\ &= 3 + j4 \end{aligned}$$

$$\begin{aligned} I_R = I_{Ph} &= \frac{V_{RY}}{Z_{eq}} \\ &= \frac{100}{3 + j4} = 20 \text{ A} \end{aligned}$$

End of Solution

Q.35 The frequencies of the stator and rotor currents flowing in a three-phase 8-pole induction motor are 40 Hz and 1 Hz, respectively. The motor speed, in rpm, is _____. (round off to nearest integer).

Ans. (585)

Stator frequency = 40 Hz, Rotor frequency = 1 Hz

Poles = 8, $N = ?$

$sf = 1$

$$\Rightarrow s = \frac{1}{40} = 0.025$$

$$N_s = \frac{120 \times 40}{8} = 600$$

$$N = N_s (1 - s)$$

$$\begin{aligned} \therefore N &= 600 (1 - 0.025) \\ &= 585 \text{ rpm} \end{aligned}$$

End of Solution

Q.36 The output impedance of a non-ideal operational amplifier is denoted by Z_{out} . The variation in the magnitude of Z_{out} with increasing frequency, f , in the circuit shown below, is best represented by

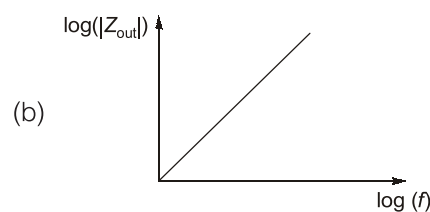
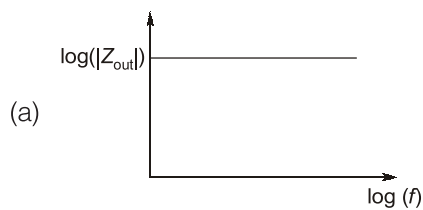
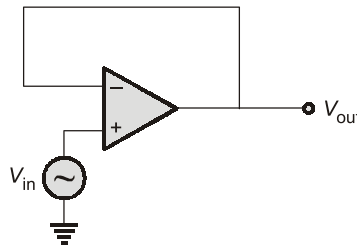

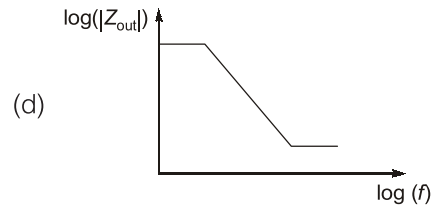
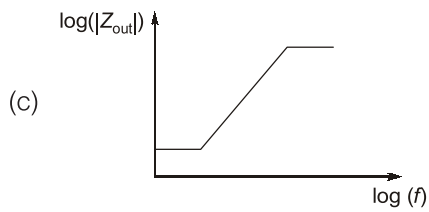

Ans. (c)

Analysis:

It is a voltage series feedback,

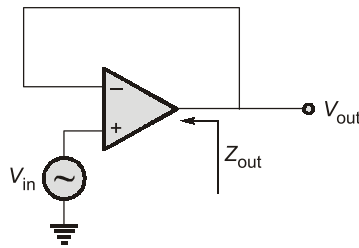

Voltage is a shunt connection,

$$Z_{out} \text{ feedback, } Z_{of} = \frac{Z_o}{1+A} = \frac{Z_o}{1+A}$$

[Buffer, $\beta = 1$]

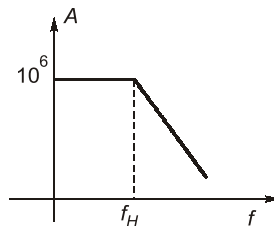

$A =$ Open loop gain

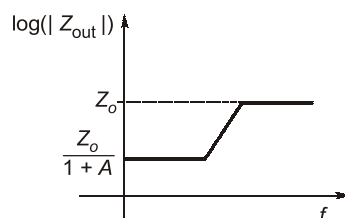

$A =$ constant (low frequency)

$$Z_{of} = \frac{Z_o}{1+A} [\text{Constant}]$$

$A =$ Decreasing

$f \rightarrow$

$$Z_{of} \uparrow = \frac{Z_o}{1+A \downarrow}$$

$A = 0$

$$Z_{of} = \frac{Z_o}{1+0} = Z_o$$

End of Solution

Q.37 An LTI system is shown in the figure where $G(s) = \frac{100}{s^2 + 0.1s + 100}$. The steady state output of the system, to the input $r(t)$, is given as $y(t) = a + b \sin(10t + \theta)$. The values of a and b will be

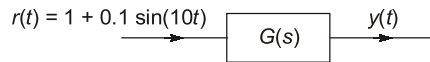

- (a) $a = 1, b = 10$
(c) $a = 1, b = 100$

- (b) $a = 10, b = 1$
(d) $a = 100, b = 1$

Ans. (a)

$$B = A|G(j\omega)|$$

$$a = 1 \times \left| \frac{100}{100 - \omega^2 + 0.1j\omega} \right|_{\omega=0}$$

$$= 1$$

$$b = 0.1 \times \left| \frac{100}{100 - \omega^2 + 0.1j\omega} \right|_{\omega=10}$$

$$= 10$$

End of Solution

Q.38 The open loop transfer function of a unity gain negative feedback system is given as

$$G(s) = \frac{1}{s(s+1)}$$

The Nyquist contour in the s -plane encloses the entire right half plane and a small neighbourhood around the origin in the left half plane, as shown in the figure below. The number of encirclements of the point $(-1 + j0)$ by the Nyquist plot of $G(s)$, corresponding to the Nyquist contour, is denoted as N . Then N equals to

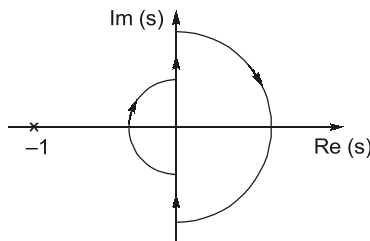

- (a) 0
(c) 2

- (b) 1
(d) 3

Ans. (b)

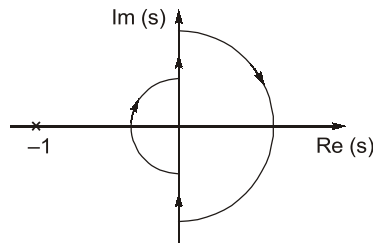

Number of Encirclement = 1

End of Solution

Q.39 The damping ratio and undamped natural frequency of a closed loop system as shown in the figure, are denoted as ξ and ω_n , respectively. The values of ξ and ω_n are

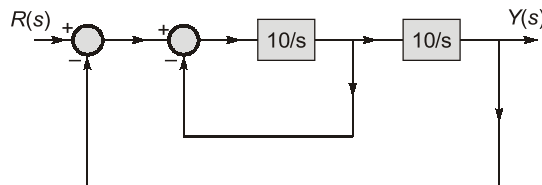

- (a) $\xi = 0.5$ and $\omega_n = 10$ rad/s (b) $\xi = 0.1$ and $\omega_n = 10$ rad/s
(c) $\xi = 0.707$ and $\omega_n = 10$ rad/s (d) $\xi = 0.707$ and $\omega_n = 100$ rad/s

Ans. (a)

Transfer function of above system after simplification is

$$\frac{C(s)}{R(s)} = \frac{100}{s^2 + 10s + 100} = \frac{\omega_n^2}{s^2 + 2\xi\omega_n s + \omega_n^2}$$

$$\omega_n = 10 \text{ rad/sec}$$

$$\xi = 0.5$$

End of Solution

Q.40 e^A denotes the exponential of a square matrix A . Suppose λ is an eigen value and v is the corresponding eigen-vector of matrix A .

Consider the following two statements :

Statement 1 : e^λ is an eigen value of e^A .

Statement 2 : v is an eigen-vector of e^A .

Which one of the following options is correct?

- (a) Statement 1 is true and statement 2 is false.
(b) Statement 1 is false and statement 2 is true.
(c) Both the statements are correct.
(d) Both the statements are false.

Ans. (c)

Given λ is an eigen value of A .

Then eigen value of $\left(e^A = 1 + A + \frac{A^2}{2!} + \frac{A^3}{3!} + \dots \right)$ is $\left(1 + \lambda + \frac{\lambda^2}{2!} + \dots = e^\lambda \right)$.

\therefore Statement (1) is true.

We know that eigen vector of A and polynomial matrix in A is same.
 \Rightarrow Eigen vector of A and e^A is same.
 \therefore Statement (2) is true.

End of Solution

Q.41 Let $f(x) = \int_0^x e^t(t-1)(t-2)dt$. Then $f(x)$ decreases in the interval.

- (a) $x \in (1, 2)$ (b) $x \in (2, 3)$
(c) $x \in (0, 1)$ (d) $x \in (0.5, 1)$

Ans. (a)

$$f(x) = \int_0^x e^t(t-1)(t-2)dt \text{ is decreasing if } f'(x) = 0.$$

By Leibnitz rule :

$$\begin{aligned} f'(x) &= \frac{d}{dx} f(x) < 0 \\ &= e^x(x-1)(x-2) \frac{d}{dx}(x) - [e^0(0-1)(0-2)] \times \left[\frac{d}{dx}(0) \right] \\ f'(x) &= [e^x(x-1)(x-2)] - 0 < 0 \\ &= (x-1)(x-2) < 0 \\ &= x > 1 \text{ and } x < 2 \\ &= x \in (1, 2) \end{aligned}$$

End of Solution

Q.42 Consider a matrix $A = \begin{bmatrix} 1 & 0 & 0 \\ 0 & 4 & -2 \\ 0 & 1 & 1 \end{bmatrix}$. The matrix A satisfies the equation $6A^{-1} = A^2 +$

$cA + dI$, where c and d are scalars and I is the identity matrix. Then $(c + d)$ is equal to

- (a) 5 (b) 17
(c) -6 (d) 11

Ans. (a)

$$A = \begin{bmatrix} 1 & 0 & 0 \\ 0 & 4 & -2 \\ 0 & 1 & 1 \end{bmatrix} \Rightarrow \lambda_A = 1$$

Given : $6A^{-1} = A^2 + cA + dI$
 $\Rightarrow 6\lambda^{-1} = \lambda^2 + c\lambda + d$

Sub. $\lambda = 1 \Rightarrow \frac{6}{1} = 1 + c + d$
 $\Rightarrow c + d = 5$

End of Solution

$$V_x = \frac{1}{C_f} \int I_{in} \times dt = \frac{I_{in}}{C_f} \times t$$

$$I_{out} = C_c \times \frac{dV_x}{dt} = C_c \times \frac{d}{dt} \left(\frac{I_{in}}{C_f} \times t \right)$$

$$= C_c \times \frac{I_{in}}{C_f}$$

$$\frac{I_{out}}{I_{in}} = \frac{C_c}{C_f}$$

End of Solution

- Q.45** If the magnetic field intensity (\vec{H}) in a conducting region is given by the expression, $\vec{H} = x^2\hat{i} + x^2y^2\hat{j} + x^2y^2z^2\hat{k}$ A/m. The magnitude of the current density, in A/m², at $x = 1$ m, $y = 2$ m and $z = 1$ m is
- (a) 8 (b) 12
(c) 16 (d) 20

Ans. (b)

Given : $\vec{H} = x^2\hat{i} + x^2y^2\hat{j} + x^2y^2z^2\hat{k}$ A/m

As $\vec{J} = \nabla \times \vec{H}$

$$\Rightarrow \vec{J} = \begin{vmatrix} \hat{a}_x & \hat{a}_y & \hat{a}_z \\ \frac{\partial}{\partial x} & \frac{\partial}{\partial y} & \frac{\partial}{\partial z} \\ x^2 & x^2y^2 & x^2y^2z^2 \end{vmatrix} = 2x^2yz^2\hat{a}_x - 2xy^2z^2\hat{a}_y + 2xy^2\hat{a}_z$$

$$\therefore \vec{J}|_{1,2,1} = 2(1)(2)(1)\hat{a}_x - 2(1)(2)^2(1)^2\hat{a}_y + 2(1)(2)\hat{a}_z$$

$$\Rightarrow \vec{J} = 4\hat{a}_x - 8\hat{a}_y + 8\hat{a}_z$$

$$\therefore |\vec{J}| = \sqrt{(4)^2 + (8)^2 + (8)^2} = 12$$

End of Solution

- Q.46** Let a causal LTI system be governed by the following differential equation $y(t) + \frac{1}{4} \frac{dy}{dt} = 2x(t)$, where $x(t)$ and $y(t)$ are the input and output respectively. Its impulse response is

- (a) $2e^{-\frac{1}{4}t}u(t)$ (b) $2e^{-4t}u(t)$
(c) $8e^{-\frac{1}{4}t}u(t)$ (d) $8e^{-4t}u(t)$



ESE 2022

Mains Exclusive

Batches

**Conventional Question Practice
Programme with Main Test Series**

OFFLINE BATCHES

3rd Mar, 2022

ONLINE BATCHES

Direct **LIVE** from Offline Classes

3rd Mar, 2022

Course Duration :
80 to 90 days

Teaching Hours :
300 to 350 hours

Class Duration :
5 to 6 days (6-7 hrs per day)

Key Features

- In-depth discussion on conventional questions.
- Beneficial to develop numerical question solving techniques.
- Helps to improve answer writing & presentation skills.
- Discussion on probable questions.
- Updated Mains workbook with wide range of practice questions sets.
- Test series will be conducted on every Sunday in synchronization with the subjects.

Register online at : www.madeeasy.in

Corporate Office : 44-A/1, Kalu Sarai, Near Hauz Khas Metro Station, New Delhi-110016

MADE EASY Centres : Delhi | Hyderabad | Jaipur | Lucknow | Bhopal | Bhubaneswar | Pune | Patna | Kolkata

📞 9021300500

🌐 www.madeeasy.in

Ans. (d)

By applying Laplace-transform on given differential equation,

$$Y(s) + \frac{1}{4}sY(s) = 2X(s)$$

$$\Rightarrow \frac{Y(s)}{X(s)} = \frac{2}{1 + \frac{s}{4}} = \frac{8}{s+4}$$

$$\Rightarrow H(s) = \frac{8}{s+4}$$

By taking inverse LT,

$$h(t) = 8e^{-4t}u(t)$$

= Impulse response of system.

End of Solution

Q.47 Let an input $x(t) = 2 \sin(10\pi t) + 5 \cos(15\pi t) + 7 \sin(42\pi t) + 4 \cos(45\pi t)$ is passed through an LTI system having an impulse response,

$$h(t) = 2 \left(\frac{\sin(10\pi t)}{\pi t} \right) \cos(40\pi t)$$

The output of the system is

(a) $2 \sin(10\pi t) + 5 \cos(15\pi t)$

(b) $5 \cos(15\pi t) + 7 \sin(42\pi t)$

(c) $7 \sin(42\pi t) + 4 \cos(45\pi t)$

(d) $2 \sin(10\pi t) + 4 \cos(45\pi t)$

Ans. (c)

Given that :

$$x(t) = 2 \sin(10\pi t) + 5 \cos(15\pi t) + 7 \sin(42\pi t) + 4 \cos(45\pi t)$$

$$h(t) = 2 \left[\frac{\sin(10\pi t)}{\pi t} \right] \cos(40\pi t)$$

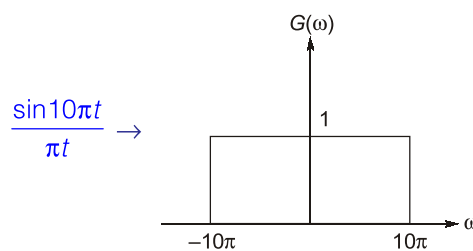

$$h(t) = 2g(t)\cos(40\pi t)$$

Apply Fourier transform

$$H(\omega) = 2 \left[\frac{G(\omega - 40\pi) + G(\omega + 40\pi)}{2} \right] = G(\omega - 40\pi) + G(\omega + 40\pi)$$

Ans. (b)

Given that :

$$x[n] = \sum_{K=0}^{N-1} a_K e^{j\left(\frac{2\pi}{N}Kn\right)}$$

$$N = 3$$

$$a_{-3} = 2$$

$$a_K = a_{K+N}$$

$$K = -3$$

$$a_{-3} = a_{-3+N} = a_{-3+3} = a_0$$

$$a_{-3} = a_0$$

$$a_4 = 1$$

$$a_4 = a_{-4}^*$$

$$a_{-4} = 1$$

$$K = 4$$

$$a_4 = a_{4+3} = a_7$$

$$a_{-4} = a_{-4+3} = a_{-1}$$

$$a_{-1} = a_1 = 1$$

$$a_1 = a_4 = 1$$

$$x[n] = \sum_{K=0}^{3-1} a_K e^{j\left(\frac{2\pi}{3}kn\right)}$$

$$= \sum_{K=0}^2 a_K e^{j\left(\frac{2\pi}{3}kn\right)}$$

$$= a_0 + a_1 e^{j\left(\frac{2\pi}{3}n\right)} + a_2 e^{j\left(\frac{2\pi}{3}2n\right)}$$

$$= 2 + 1 \cdot e^{j\left(\frac{2\pi}{3}n\right)} + 0$$

$$x[n] = 2 + e^{j\left(\frac{2\pi}{3}n\right)}$$

$$= 1 + e^{j\left(\frac{2\pi}{3}n\right)} + 1$$

$$= 1 + e^{\frac{j2\pi}{3}n} + e^{-\frac{j2\pi}{6}n} \cdot e^{\frac{j2\pi}{6}n}$$

$$= 1 + e^{\frac{j2\pi}{6}n} \left[e^{\frac{j2\pi}{6}n} + e^{-\frac{j2\pi}{6}n} \right]$$

$$= 1 + 2e^{\frac{j2\pi}{6}n} \left[\frac{e^{\frac{j2\pi}{6}n} + e^{-\frac{j2\pi}{6}n}}{2} \right]$$

$$= 1 + 2e^{\frac{j2\pi}{6}n} \cos\left(\frac{2\pi}{6}n\right)$$

End of Solution

Q.50 Let $f(x, y, z) = 4x^2 + 7xy + 3xz^2$. The direction in which the function $f(x, y, z)$ increases most rapidly at point $P = (1, 0, 2)$ is

- (a) $20\hat{i} + 7\hat{j}$ (b) $20\hat{i} + 7\hat{j} + 12\hat{k}$
(c) $20\hat{i} + 12\hat{k}$ (d) $20\hat{i}$

Ans. (b)

Scalar function $f(x, y, z)$ rapidly increases in the direction of its normal vector at P .

$$\begin{aligned} \therefore \bar{a} &= \nabla f \\ &= \left(i \frac{\partial}{\partial x} + j \frac{\partial}{\partial y} + k \frac{\partial}{\partial z} \right) f \\ &= i(8x + 7y + 3z^2) + j(7x) + k(6xz) \\ (\nabla f)_{(1,0,2)} &= 20i + 7j + 12k \end{aligned}$$

End of Solution

Q.51 Let R be a region in the first quadrant of the xy plane enclosed by a closed curve C considered in counter-clockwise direction. Which of the following expressions does not represent the area of the region R ?

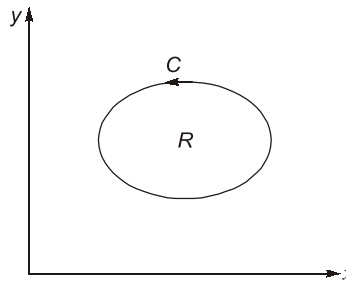

- (a) $\iint_R dx dy$ (b) $\oint_C x dy$
(c) $\oint_C y dx$ (d) $\frac{1}{2} \oint_C (x dy - y dx)$

Ans. (c)

(a) $\iint_R dx dy = \text{Area of region } R \text{ bounded by } C$

By Green's

(b) $\oint_C x dy = \iint_R (1-0) dx dy = \text{Area of } R \text{ bounded by } C$

By Green's

(c) $\oint_C y dx = \iint_R (0-1) dx dy = -[\text{Area of } R]$

By Green's

(d) $\frac{1}{2} \oint_C x dy - y dx = \frac{1}{2} \iint_R [1 - (-1)] dx dy = \text{Area of } R$

End of Solution

- (a) $V(r) = \frac{cd(V_2 - V_1)}{(d-c)r} - \frac{V_1c + V_2d - 2V_1d}{d-c}$
- (b) $V(r) = \frac{cd(V_1 - V_2)}{(d-c)r} + \frac{V_2d - V_1c}{d-c}$
- (c) $V(r) = \frac{cd(V_1 - V_2)}{(d-c)r} - \frac{V_1c - V_2c}{d-c}$
- (d) $V(r) = \frac{cd(V_2 - V_1)}{(d-c)r} - \frac{V_2c - V_1c}{d-c}$

Ans. (b)

From Laplace's equation,

$$\nabla^2 V = 0$$

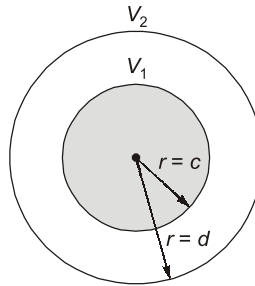

For spherical co-ordinate system,

$$\begin{matrix} h_1 & h_2 & h_3 \\ 1 & r & r \sin \theta \end{matrix}$$

$$\therefore \nabla^2 V = \frac{1}{r^2 \sin \theta} \left[\frac{\partial}{\partial r} \left(\frac{r^2 \sin \theta}{1} \cdot \frac{\partial V}{\partial r} \right) \right] = 0$$

$$\Rightarrow r^2 \frac{dV}{dr} = A; A = \text{Constant}$$

$$\Rightarrow \frac{dV}{dr} = \frac{A}{r^2}$$

$$\Rightarrow V = \frac{-A}{r} + B; B = \text{Constant}$$

$$\text{at } r = c; \quad V = V_1$$

$$\Rightarrow V_1 = \frac{-A}{c} + B \quad \dots(1)$$

$$\text{at } r = d; \quad V = V_2$$

$$\Rightarrow V_2 = \frac{-A}{d} + B \quad \dots(2)$$

(1) - (2), we get

$$V_1 - V_2 = \frac{-A}{c} + \frac{A}{d}$$

$$\Rightarrow V_1 - V_2 = A \left[\frac{c-d}{cd} \right]$$

$$\Rightarrow A = \left(\frac{V_1 - V_2}{c - d} \right) cd$$

From (1),

$$B = V_1 + \frac{A}{c}$$

$$\Rightarrow B = V_1 + \left(\frac{V_1 - V_2}{c - d} \right) d$$

$$\therefore V = \frac{-\left(\frac{V_1 - V_2}{c - d} \right) cd}{r} + V_1 + d \left(\frac{V_1 - V_2}{c - d} \right)$$

$$\Rightarrow V(r) = \frac{(V_1 - V_2)cd}{(d - c)r} + V_1 - d \left(\frac{V_1 - V_2}{d - c} \right)$$

$$\Rightarrow V(r) = \frac{(V_1 - V_2)cd}{(d - c)r} + \frac{V_1 d - V_1 c - V_1 d + V_2 d}{d - c}$$

$$\Rightarrow V(r) = \frac{cd(V_1 - V_2)}{(d - c)r} + \frac{V_2 d - V_1 c}{d - c}$$

End of Solution

Q.54 Let the probability density function of a random variable x be given as

$$f(x) = ae^{-2|x|}$$

The value of a is _____.

Ans. (1)

$f(x)$ is a p.d.f. if $\int_{-\infty}^{\infty} f(x) dx = 1$.

$$\Rightarrow \int_{-\infty}^{\infty} ae^{-2|x|} dx = 1$$

$$\Rightarrow \int_{-\infty}^0 ae^{2x} dx + \int_0^{\infty} ae^{-2(x)} dx = 1$$

$$= a \left[\frac{e^{2x}}{2} \right]_{-\infty}^0 + a \left[\frac{e^{-2x}}{-2} \right]_0^{\infty} = 1$$

$$\Rightarrow \frac{a}{2} + \frac{a}{2} = 1$$

$$\Rightarrow a = 1$$

End of Solution

Q.55 In the circuit shown below, the magnitude of the voltage V_1 in volts, across the $8 \text{ k}\Omega$ resistor is _____. (round off to nearest integer).

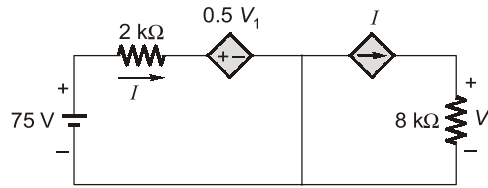

Ans. (100)

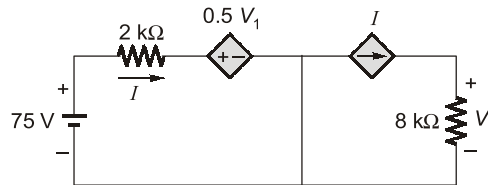

The voltage across $8\text{ k}\Omega$ is

$$V_1 = 8kI$$

Write KVL equation in first loop.

$$75 = 2kI + 0.5V_1$$

$$I = \frac{75 - 0.5V_1}{2k}$$

$$V_1 = 8k \left(\frac{75 - 0.5V_1}{2k} \right)$$

$$V_1 = 100\text{ V}$$

End of Solution

- Q.56** Two generating units rated for 250 MW and 400 MW have governor speed regulations of 6% and 6.4%, respectively, from no load to full load. Both the generating units are operating in parallel to share a load of 500 MW. Assuming free governor action, the load shared in MW, by the 250 MW generating unit is _____. (round off to nearest integer).

Ans. (200)

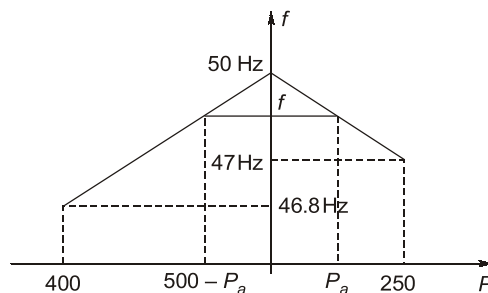

$$\frac{3}{250} = \frac{50 - f}{P_a} \quad \dots(i)$$

$$\frac{3.2}{400} = \frac{50 - f}{500 - P_a} \quad \dots(ii)$$

Equation (i) divide by equation (ii),

$$\frac{3/250}{3.2/400} = \frac{500 - P_a}{P_a}$$

$$1.5 = \frac{500 - P_a}{P_a}$$

$$P_a = 200 \text{ MW}$$

End of Solution

Q.57 A 20 MVA, 11.2 kV, 4-pole, 50 Hz alternator has an inertia constant of 15 MJ/MVA. If the input and output powers of the alternator are 15 MW and 10 MW, respectively, the angular acceleration in mechanical degree/s² is _____. (round off to nearest integer).

Ans. (75)

$$M \frac{d^2\delta}{dt^2} = P_a$$

$$P_a = 15 - 10 = 5$$

So,

$$m\alpha = P_a$$

$$\alpha = \frac{P_a}{m}$$

$$m = \frac{Hs}{180f} = \frac{15 \times 20}{180 \times 50} = \frac{1}{30}$$

So,

$$\alpha = \frac{5}{1/30} = 150 \text{ electrical degree/sec}^2$$

$$\alpha = 150 \times \frac{2}{P} \text{ mechanical degree/sec}^2$$

$$\alpha = 75 \text{ mechanical degree}$$

End of Solution

Q.58 Consider an ideal full-bridge single-phase DC-AC inverter with a DC bus voltage magnitude of 1000 V. The inverter output voltage $v(t)$ shown below, is obtained when diagonal switches of the inverter are switched with 50% duty cycle. The inverter feeds a load

with a sinusoidal current given by, $i(t) = 10 \sin\left(\omega t - \frac{\pi}{3}\right) \text{ A}$, where $\omega = \frac{2\pi}{T}$. The active power, in watts, delivered to the load is _____. (round off to nearest integer).

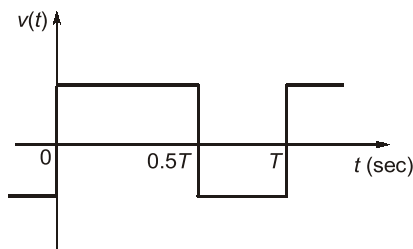



Announcing

SUPER TALENT BATCHES

for **ESE 2023 & GATE 2023**

Batches commencing from

27th April, 2022

CE, ME

28th April, 2022

EE, EC

- **Course duration** : 6-7 months
- **Teaching hours** : 1000-1200

Note : These batches will be conducted only at Delhi Centre.

Key Features

- Highly competitive environment.
- Meritorious students group.
- Classes by senior faculty members.
- In-depth coverage of syllabus.
- Focus on problem solving techniques.

Register online at : www.madeeasy.in

Corporate Office : 44-A/1, Kalu Sarai, Near Hauz Khas Metro Station, New Delhi-110016

MADE EASY Centres : Delhi | Hyderabad | Jaipur | Lucknow | Bhopal | Bhubaneswar | Pune | Patna | Kolkata

☎ **9021300500**

🌐 www.madeeasy.in

Ans. (3182)

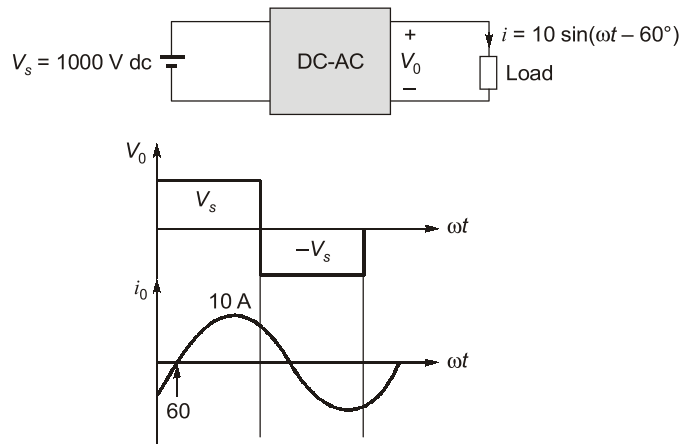

$$\begin{aligned}
 P_0 &= P_{01} \\
 &= V_{01} \cdot I_{0r} \cdot \cos(60^\circ) \\
 &= \left(\frac{2\sqrt{2}}{\pi} \cdot (1000) \right) \cdot \left(\frac{10}{\sqrt{2}} \right) \times (0.5) \\
 &\simeq 3182 \text{ W}
 \end{aligned}$$

End of Solution

Q.59 For the ideal AC-DC rectifier circuit shown in the figure below, the load current magnitude is $I_{dc} = 15 \text{ A}$ and is ripple free. The thyristors are fired with a delay angle of 45° . The amplitude of the fundamental component of the source current, in amperes, is _____. (round off to two decimal places).

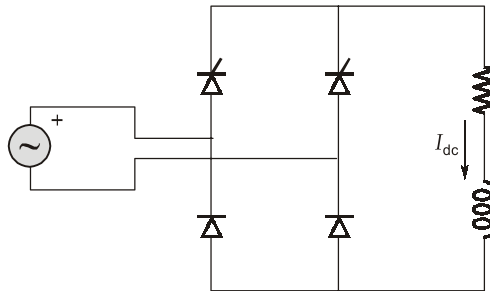

Ans. (17.65)

$$\begin{aligned}
 \hat{I}_{s1} &= \frac{4 \cdot I_0}{n\pi} \cos\left(\frac{n\alpha}{2}\right) \\
 \hat{I}_{s1} &= \frac{4 \times 15}{\pi} \cos(22.5^\circ) = 17.65 \text{ A}
 \end{aligned}$$

End of Solution

Q.60 A 3-phase grid-connected voltage source converter with DC link voltage of 1000 V is switched using sinusoidal Pulse Width Modulation (PWM) technique. If the grid phase current is 10 A and the 3-phase complex power supplied by the converter is given by $(-4000 - j3000)$ VA, then the modulation index used in sinusoidal PWM is _____. (round off to two decimal places).

Ans. (0.47)

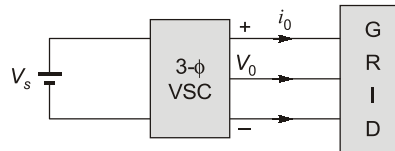

$$S = (-4000 - j3000) \text{ VA}$$

$$P_0 = \sqrt{3} \cdot V_{L1} \cdot I_{0r} \cdot (\text{pF})$$

$$4000 = \sqrt{3} \cdot V_{L1} \cdot 10 \times \left(\frac{4000}{\sqrt{4000^2 + 3000^2}} \right)$$

$$V_{L1(\text{rms})} = 288.675 \text{ V}$$

$$3\text{-}\phi \text{ VSI - SPWM, } M_A \leq 1$$

$$\hat{V}_{L1} = \sqrt{3} \cdot M_A \cdot \frac{V_s}{2}$$

$$V_{L1(\text{rms})} = M_A \left(\frac{\sqrt{3}}{2\sqrt{2}} \times 1000 \right)$$

$$288.675 = M_A \left(\frac{\sqrt{3}}{2\sqrt{2}} \times 1000 \right)$$

$$M_A = 0.47$$

End of Solution

Q.61 The steady state current flowing through the inductor of a DC-DC buck boost converter is given in the figure below. If the peak-to-peak ripple in the output voltage of the converter is 1 V, then the value of the output capacitor, in μF , is _____. (round off to nearest integer).

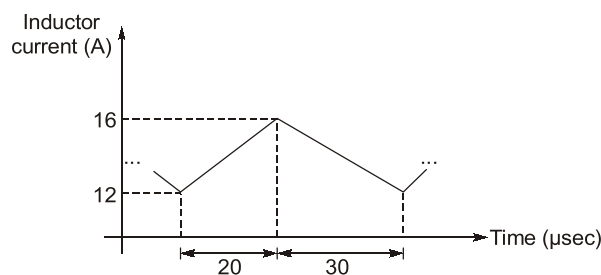

Ans. (168)

$$I_L = \frac{I_{\max} + I_{\min}}{2} = \frac{16 + 12}{2} = 14 \text{ A}$$

$$I_0 = I_L(1 - \alpha)$$

$$I_0 = 14 \times \left(\frac{30}{50}\right) = 8.4 \text{ A}$$

$$\Delta V_0 = \Delta V_c = \frac{\alpha \cdot I_0}{f \cdot C}$$

$$1 = \frac{\left(\frac{2}{5}\right) \times 8.4}{\frac{1}{50 \cdot 10^{-6}} \cdot C}$$

$$C = 168 \mu\text{F}$$

End of Solution

Q.62 A 280 V, separately excited DC motor with armature resistance of 1Ω and constant field excitation drives a load. The load torque is proportional to the speed. The motor draws a current of 30 A when running at a speed of 1000 rpm. Neglect frictional losses in the motor. The speed, in rpm, at which the motor will run, if an additional resistance of value 10Ω is connected in series with the armature, is _____. (round off to nearest integer).

Ans. (483)

Given: $V = 280$, Sep. excited motor, $R_a = 1 \Omega$, ϕ : Constant, $T_a \propto I_a = 30 \text{ A}$, $N = 1000 \text{ rpm}$, $R_{\text{ext}} = 10 \Omega$

$$\begin{aligned} T &\propto \phi I_a \\ \therefore \text{Flux constant, } T &\propto I_a \end{aligned}$$

$$\frac{T_2}{T_1} = \frac{I_{a2}}{I_{a1}}$$

$$\text{Given: } T \propto N$$

$$\therefore \frac{T_2}{T_1} = \frac{N_2}{N_1}$$

$$\therefore \frac{I_{a2}}{I_{a1}} = \frac{N_2}{N_1}$$

$$\text{Let, } I_{a1} = 30 \text{ A, } N_1 = 1000 \text{ rpm}$$

$$\therefore I_{a2} = \frac{30}{1000} (N_2)$$

$$I_{a2} = 0.03 N_2$$

$$N \propto \frac{E_f}{\phi}$$

$$\frac{N_2}{N_1} = \frac{E_{b2}}{E_{b1}} \Rightarrow \frac{N_2}{N_1} = \frac{V - I_{a2}(R_a + R_{\text{ext}})}{V - I_{a1}R_a}$$

$$\frac{N_2}{1000} = \frac{280 - 0.03N_2(1+10)}{280 - 30(1)} = \frac{280 - 0.33N_2}{250}$$

$$250N_2 = 280 \times 1000 - 330 N_2$$

$$N_2 = 482.76 \text{ rpm}$$

End of Solution

Q.63 A 4-pole induction motor with inertia of 0.1 kg-m^2 drives a constant load torque of 2 Nm . The speed of the motor is increased linearly from 1000 rpm to 1500 rpm in 4 seconds as shown in the figure below. Neglect losses in the motor. The energy, in joules, consumed by the motor during the speed change is _____. (round off to nearest integer).

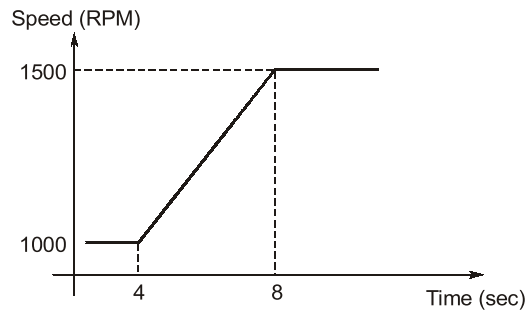

Ans. (1733)

Equation of speed vs. time from 4 sec to 8 sec .

$$N = 125t + 500 \Rightarrow 4 \text{ sec} \leq t \leq 8 \text{ sec}$$

Now, $J \frac{d\omega}{dt} = T_e - T_L$

or $T_e = J \frac{d\omega}{dt} + T_L$

or $\omega T_e = J\omega \frac{d\omega}{dt} + \omega T_L$

or $P_e = J\omega \frac{d\omega}{dt} + \omega T_L$

or $\frac{dE}{dt} = J\omega \frac{d\omega}{dt} + \omega T_L$

or $dE = J\omega d\omega + T_L \omega dt$

or $E = \int J\omega d\omega + T_L \int \omega dt$

or $E = J \left(\frac{2\pi}{60} \right)^2 \int_{1000}^{1500} N dN + T_L \frac{2\pi}{60} \int_4^8 N dt$

$$= J \left(\frac{2\pi}{60} \right)^2 \left(\frac{N^2}{2} \right)_{1000}^{1500} + 2 \cdot \frac{2\pi}{60} \int_4^8 (125t + 500) dt$$

$$= 0.1 \times \left(\frac{2\pi}{60} \right)^2 \left(\frac{1500^2 - 1000^2}{2} \right) + 2 \cdot \frac{2\pi}{60} \left[\frac{125t^2}{2} + 500t \right]_4^8$$

$$= 685.389 + 1047.197$$

$$= 1732.5865 \text{ J}$$

End of Solution

Q.64 A star-connected 3-phase, 400 V, 50 kVA, 50 Hz synchronous motor has a synchronous reactance of 1 ohm per phase with negligible armature resistance. The shaft load on the motor is 10 kW while the power factor is 0.8 leading. The loss in the motor is 2 kW. The magnitude of the per phase excitation emf of the motor, in volts, is _____. (round off to nearest integer).

Ans. (245)

Y-connected, 3 phase, 400V, 50 kVA, Synch motor, $X_s = 1 \Omega/\text{ph}$, Shaft load $P_{sh} = 10 \text{ kW}$, p.f. = 0.8 loading losses = 2 kW, R_a : Negligible
Find excitation EMF (E_b):

$$E_b = \sqrt{(V \cos \phi - I_a R_a)^2 + (V \sin \phi \pm I_a X_s)^2} \quad (+ \text{ for Lead and } - \text{ for lag})$$

To find I_a : Current drawn, we need to find Input.

$$\text{Input} = \text{Output} + \text{Losses} + P_{sh} + \text{Losses} = 10 + 2 = 12 \text{ kW}$$

$$\sqrt{3} V_L I_L \cos \phi = 12 \text{ kW}$$

$$I_L = \frac{12000}{\sqrt{3} \times 400 \times 0.8} = 21.65 \text{ A} = I_a$$

$$E_b = \sqrt{\left(\frac{400}{\sqrt{3}} \times 0.8\right)^2 + \left[\frac{400}{\sqrt{3}} \times 0.6 + 21.65(1)\right]^2}$$

$$E_b = \sqrt{(V \cos \phi - I_a R_a)^2 + (V \sin \phi + I_a X_s)^2}$$

$$= \sqrt{34135.336 + (138.568 + 21.65)^2}$$

$$E_b = 244.55 \text{ V per phase}$$

End of Solution

Q.65 A 3-phase, 415 V, 50 Hz induction motor draws 5 times the rated current at rated voltage at starting. It is required to bring down the starting current from the supply to 2 times of the rated current using a 3-phase autotransformer. If the magnetizing impedance of the induction motor and no load current of the autotransformer is neglected, then the transformation ratio of the autotransformer is given by _____. (round off to two decimal places).

Ans. (0.63)

$$\text{Given: } I_{sc} = 5 I_{rated} \Rightarrow I_{sc} = 5 I_f$$

It is required to make starting current to " $2I_f$ " using auto transformer.

Line current with auto transformer,

$$I_L = x^2 I_{sc}$$

$$\text{Given: } I_L = 2I_f \Rightarrow 2I_f = x^2 I_{sc}$$

$$\frac{2I_f}{I_{sc}} = x^2$$

$$\Rightarrow x^2 = 2 \times \left(\frac{1}{5}\right) \Rightarrow x = \sqrt{\frac{2}{5}} = 0.63$$

End of Solution

